

# 9

## Press fitinky



|               |     |
|---------------|-----|
| Press fitinky | 222 |
| Nářadí        | 237 |

## Press fitinky



### Technická data

Maximální provozní tlak 10 bar  
Maximální provozní teplota 95 °C  
Maximální krátkodobá teplota (1 hod.) 110 °C

### Konstrukční vlastnosti

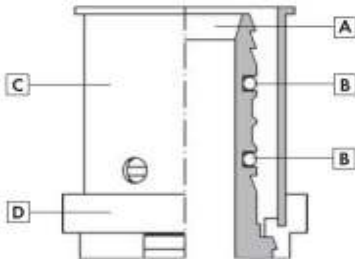

A - tělo z mosazi EN 12165 CW617N  
B - o-kroužky z E.P.D.M.  
C - utahovací objímka z nerez oceli  
AISI 304 DIN EN 10088-2  
D - Průhledný plastový kroužek z PE-LD, pro kontrolu správného zasazení trubky do fitinky; poskytuje trubce dielektrickou izolaci od těla fitinky

### Lisovací profil pro press fitinky Comisa



| TH |
|----|
| 16 |
| 18 |
| 20 |
| 26 |
| 32 |
| 40 |
| 50 |
| 63 |

### Kompatibilita s lisovacími čelistmi H - B

| H  | B  |
|----|----|
| 16 | 16 |
| 18 | 20 |
| 20 | 26 |
| 26 | 32 |
| 32 |    |

Tabulka tlakových ztrát podle typu fitinek (hodnoty v ekvivalentních metrech)

|            | 1    | 2    | 3    | 4    | 5     | 6    | 7    |
|------------|------|------|------|------|-------|------|------|
| Ø 16 x 2,0 | 0,80 | 0,70 | 0,60 | 1,40 | 1,80  | 0,35 | 0,80 |
| Ø 18 x 2,0 | 1,00 | 0,90 | 0,80 | 1,60 | 2,10  | 0,45 | 1,00 |
| Ø 20 x 2,5 | 1,10 | 1,00 | 0,90 | 1,70 | 2,20  | 0,45 | 1,10 |
| Ø 20 x 2,0 | 1,30 | 1,15 | 1,00 | 1,90 | 2,70  | 0,50 | 1,30 |
| Ø 26 x 3,0 | 1,80 | 1,60 | 1,40 | 2,50 | 4,30  | 0,65 | 1,80 |
| Ø 32 x 3,0 | 2,70 | 2,30 | 2,00 | 4,20 | 6,30  | 0,85 | 2,70 |
| Ø 40 x 3,5 | 3,00 | 2,60 | 2,30 | 5,00 | 7,50  | 1,00 | 3,00 |
| Ø 50 x 4,0 | 4,60 | 4,20 | 3,80 | 6,70 | 10,00 | 1,30 | 4,60 |

## Press fitinky



### 201

Spojka vnější závit

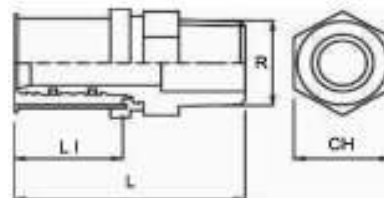

| kód      | rozměr   | L  | L1 | R      | CH |   |   | balení | cena v Kč |
|----------|----------|----|----|--------|----|---|---|--------|-----------|
| 20101216 | 1/2*16   | 50 | 25 | 1/2"   | 22 | - | - | 10/120 | 44,-      |
| 20101218 | 1/2*18   | 50 | 25 | 1/2"   | 22 | - | - | 10/120 | 59,- *    |
| 20103418 | 3/4*18   | 54 | 25 | 3/4"   | 27 | - | - | 10/120 | 92,- *    |
| 20101220 | 1/2*20   | 50 | 25 | 1/2"   | 22 | - | - | 10/120 | 55,-      |
| 20103420 | 3/4*20   | 54 | 25 | 3/4"   | 27 | - | - | 10/100 | 76,-      |
| 20101226 | 1/2*26   | 53 | 25 | 1/2"   | 27 | - | - | 5/60   | 142,-     |
| 20103426 | 3/4*26   | 54 | 25 | 3/4"   | 27 | - | - | 5/60   | 109,-     |
| 20100126 | 1*26     | 57 | 25 | 1"     | 34 | - | - | 5/50   | 139,-     |
| 20100132 | 1*32     | 57 | 25 | 1"     | 34 | - | - | 1/40   | 154,-     |
| 20111432 | 1 1/4*32 | 62 | 25 | 1 1/4" | 43 | - | - | 1/30   | 218,- *   |
| 20100140 | 1*40     | 62 | 25 | 1"     | 43 | - | - | 1/20   | 286,- *   |
| 20111440 | 1 1/4*40 | 62 | 25 | 1 1/4" | 43 | - | - | 1/20   | 268,- *   |
| 20111450 | 1 1/4*50 | 73 | 40 | 1 1/4" | 50 | - | - | 1/10   | 566,- *   |
| 20111250 | 1 1/2*50 | 73 | 40 | 1 1/2" | 50 | - | - | 1/10   | 514,- *   |
| 20100263 | 2*63     | 85 | 37 | 2"     | 60 | - | - | 1/5    | 1397,- *  |



### 202

Spojka vnitřní závit

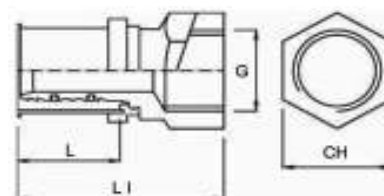

| kód      | rozměr   | L  | L1 | G      | CH |   |   | balení | cena v Kč |
|----------|----------|----|----|--------|----|---|---|--------|-----------|
| 20201216 | 1/2*16   | 50 | 25 | 1/2"   | 25 | - | - | 10/120 | 55,-      |
| 20201218 | 1/2*18   | 50 | 25 | 1/2"   | 25 | - | - | 10/120 | 74,- *    |
| 20203418 | 3/4*18   | 53 | 25 | 3/4"   | 30 | - | - | 10/100 | 91,- *    |
| 20201220 | 1/2*20   | 50 | 25 | 1/2"   | 25 | - | - | 10/120 | 68,-      |
| 20203420 | 3/4*20   | 53 | 25 | 3/4"   | 30 | - | - | 10/80  | 90,-      |
| 20203426 | 3/4*26   | 53 | 25 | 3/4"   | 30 | - | - | 5/60   | 119,-     |
| 20200126 | 1*26     | 53 | 25 | 1"     | 38 | - | - | 5/50   | 152,-     |
| 20200132 | 1*32     | 53 | 25 | 1"     | 38 | - | - | 1/40   | 170,-     |
| 20211432 | 1 1/4*32 | 57 | 25 | 1 1/4" | 50 | - | - | 1/30   | 344,-     |
| 20200140 | 1*40     | 53 | 25 | 1"     | 43 | - | - | 1/20   | 305,- *   |
| 20211440 | 1 1/4*40 | 57 | 25 | 1 1/4" | 50 | - | - | 1/20   | 414,- *   |
| 20211240 | 1 1/2*40 | 57 | 25 | 1 1/2" | 50 | - | - | 1/20   | 414,- *   |
| 20211450 | 1 1/4*50 | 70 | 40 | 1 1/4" | 50 | - | - | 1/10   | 501,- *   |
| 20211250 | 1 1/2*50 | 73 | 40 | 1 1/2" | 50 | - | - | 1/10   | 522,- *   |
| 20200263 | 2*63     | -  | -  | 2"     | -  | - | - | 1/5    | 1274,- *  |

## Press fitinky



### 203

Spojka s převlečnou maticí  
Eurokonus



| kód      | rozměr  | L  | L1 | G    | CH |   |   | balení | cena v Kč |
|----------|---------|----|----|------|----|---|---|--------|-----------|
| 20303416 | 3/4"×16 | 48 | 25 | 3/4" | 30 | - | - | 10/100 | 117,-     |
| 20303418 | 3/4"×18 | 48 | 25 | 3/4" | 30 | - | - | 10/100 | 132,- *   |
| 20303420 | 3/4"×20 | 48 | 25 | 3/4" | 30 | - | - | 10/100 | 125,-     |
| 20300126 | 1"×26   | 44 | 25 | 1"   |    | - | - | 10/70  | 171,-     |



### 204

Spojka s převlečnou maticí  
Ploché těsnění

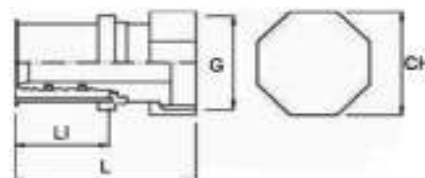

| kód      | rozměr  | L  | L1 | G    | CH |   |   | balení | cena v Kč |
|----------|---------|----|----|------|----|---|---|--------|-----------|
| 20401216 | 1/2"×16 | 52 | 25 | 1/2" | 24 | - | - | 10/100 | 86,-      |
| 20403416 | 3/4"×16 | 48 | 25 | 3/4" | 30 | - | - | 10/100 | 98,-      |
| 20403418 | 3/4"×18 | 48 | 25 | 3/4" | 30 | - | - | 10/100 | 101,- *   |
| 20403420 | 3/4"×20 | 48 | 25 | 3/4" | 30 | - | - | 10/100 | 105,-     |
| 20400126 | 1"×26   | 45 | 25 | 1"   | 37 | - | - | 5/80   | 161,-     |



### 205

Spojka

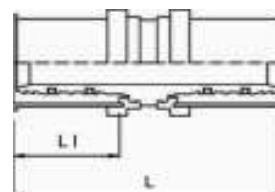

| kód      | rozměr | L  | L1 |   |   |   |   | balení | cena v Kč |
|----------|--------|----|----|---|---|---|---|--------|-----------|
| 20501616 | 16×16  | 63 | 25 | - | - | - | - | 10/100 | 67,-      |
| 20501818 | 18×18  | 63 | 25 | - | - | - | - | 10/100 | 83,- *    |
| 20502020 | 20×20  | 63 | 25 | - | - | - | - | 10/80  | 84,-      |
| 20502626 | 26×26  | 63 | 25 | - | - | - | - | 5/50   | 125,-     |
| 20503232 | 32×32  | 68 | 25 | - | - | - | - | 1/30   | 191,-     |
| 20504040 | 40×40  | 71 | 25 | - | - | - | - | 1/30   | 329,- *   |
| 20505050 | 50×50  | 96 | 40 | - | - | - | - | 1/10   | 596,- *   |
| 20506363 | 63×63  | 82 | 37 | - | - | - | - | 1/5    | 1541,- *  |

## Press fitinky



### 206

Spojka redukovaná

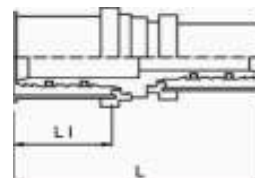

| kód      | rozměr | L  | L1    |   |   |   |   | balení | cena v Kč |
|----------|--------|----|-------|---|---|---|---|--------|-----------|
| 20601620 | 16*20  | 63 | 25    | - | - | - | - | 10/80  | 88,-      |
| 20601626 | 16*26  | 63 | 25    | - | - | - | - | 5/50   | 117,-     |
| 20601618 | 16*18  | 63 | 25    | - | - | - | - | 10/100 | 86,- *    |
| 20601820 | 18*20  | 63 | 25    | - | - | - | - | 10/80  | 92,- *    |
| 20601826 | 18*26  | 63 | 25    | - | - | - | - | 5/50   | 133,- *   |
| 20602026 | 20*26  | 63 | 25    | - | - | - | - | 5/50   | 120,-     |
| 20603216 | 32*16  | 68 | 25    | - | - | - | - | 1/50   | 172,-     |
| 20603218 | 32*18  | 68 | 25    | - | - | - | - | 1/50   | 174,- *   |
| 20603220 | 32*20  | 68 | 25    | - | - | - | - | 1/50   | 174,-     |
| 20603226 | 32*26  | 68 | 25    | - | - | - | - | 1/50   | 174,-     |
| 20604026 | 40*26  | 71 | 25    | - | - | - | - | 1/30   | 305,- *   |
| 20604032 | 40*32  | 71 | 25    | - | - | - | - | 1/30   | 314,- *   |
| 20605032 | 50*32  | 81 | 40*25 | - | - | - | - | 1/10   | 512,- *   |
| 20605040 | 50*40  | 81 | 40*25 | - | - | - | - | 1/10   | 520,- *   |
| 20606340 | 63*40  | 73 | 37*25 | - | - | - | - | 1/10   | 1541,- *  |
| 20606350 | 63*50  | 89 | 37*40 | - | - | - | - | 1/10   | 1664,- *  |



### 211

Koleno 90°



| kód      | rozměr | L  | L1 |   |   |   |   | balení | cena v Kč |
|----------|--------|----|----|---|---|---|---|--------|-----------|
| 21101616 | 16*16  | 45 | 25 | - | - | - | - | 10/80  | 83,-      |
| 21101818 | 18*18  | 45 | 25 | - | - | - | - | 10/80  | 115,- *   |
| 21102020 | 20*20  | 45 | 25 | - | - | - | - | 10/60  | 98,-      |
| 21102626 | 26*26  | 45 | 25 | - | - | - | - | 5/40   | 149,-     |
| 21103232 | 32*32  | 52 | 25 | - | - | - | - | 1/20   | 202,-     |
| 21104040 | 40*40  | 56 | 25 | - | - | - | - | 1/15   | 350,- *   |
| 21105050 | 50*50  | 76 | 40 | - | - | - | - | 1/10   | 653,- *   |
| 21106363 | 63*63  | 83 | 37 | - | - | - | - | 1/5    | 2157,- *  |



### 212

Koleno 45°

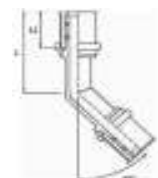

| kód      | rozměr | L  | L1 |   |   |   |   | balení | cena v Kč |
|----------|--------|----|----|---|---|---|---|--------|-----------|
| 21202626 | 26*26  | 56 | 25 | - | - | - | - | 5/40   | 241,-     |
| 21203232 | 32*32  | 56 | 25 | - | - | - | - | 1/20   | 275,-     |
| 21204040 | 40*40  | 56 | 25 | - | - | - | - | 1/20   | 473,- *   |
| 21205050 | 50*50  | 77 | 40 | - | - | - | - | 1/5    | 751,- *   |

## Press fitinky



### 213

Koleno 90°  
Vnější závit

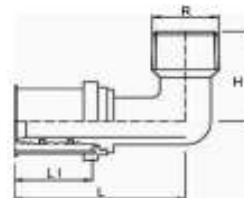

| kód      | rozměr   | L  | L1 | H  | R      |   |   | balení | cena v Kč |
|----------|----------|----|----|----|--------|---|---|--------|-----------|
| 21301216 | 1/2*16   | 47 | 25 | 29 | 1/2"   | - | - | 10/80  | 87,-      |
| 21301218 | 1/2*18   | 54 | 25 | 31 | 1/2"   | - | - | 10/80  | 94,- *    |
| 21301220 | 1/2*20   | 54 | 25 | 31 | 1/2"   | - | - | 10/80  | 98,-      |
| 21303420 | 3/4*20   | 49 | 25 | 34 | 3/4"   | - | - | 10/60  | 102,-     |
| 21303426 | 3/4*26   | 49 | 25 | 39 | 3/4"   | - | - | 5/40   | 137,-     |
| 21300132 | 1*32     | 52 | 25 | 43 | 1"     | - | - | 1/20   | 179,-     |
| 21311440 | 1 1/4*40 | 55 | 25 | 54 | 1 1/4" | - | - | 1/15   | 353,- *   |
| 21311450 | 1 1/4*50 | 76 | 40 | 61 | 1 1/4" | - | - | 1/10   | 566,- *   |
| 21311250 | 1 1/2*50 | 76 | 40 | 61 | 1 1/2" | - | - | 1/10   | 588,- *   |



### 214

Koleno 90°  
Vnitřní závit

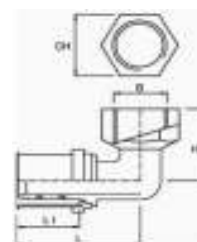

| kód      | rozměr        | L  | L1 | H  | G      | CH |   | balení | cena v Kč |
|----------|---------------|----|----|----|--------|----|---|--------|-----------|
| 21431216 | 1/2*16 - 33mm | 54 | 25 | 33 | 1/2"   | \  | - | 10/80  | 101,-     |
| 21421216 | 1/2*16 - 25mm | 47 | 25 | 25 | 1/2"   | 25 | - | 10/80  | 70,-      |
| 21401218 | 1/2*18        | 48 | 25 | 26 | 1/2"   | 26 | - | 10/80  | 101,- *   |
| 21403418 | 3/4*18        | 49 | 25 | 34 | 3/4"   | 31 | - | 10/60  | 136,- *   |
| 21401220 | 1/2*20        | 48 | 25 | 26 | 1/2"   | 26 | - | 10/60  | 93,-      |
| 21403420 | 3/4*20        | 49 | 25 | 34 | 3/4"   | 31 | - | 10/50  | 126,-     |
| 21403426 | 3/4*26        | 49 | 25 | 42 | 3/4"   | 31 | - | 5/40   | 145,-     |
| 21400132 | 1*32          | 52 | 25 | 45 | 1"     | 38 | - | 1/20   | 184,-     |
| 21411440 | 1 1/4*40      | 56 | 25 | 55 | 1 1/4" | 47 | - | 1/15   | 353,- *   |
| 21411450 | 1 1/4*50      | 76 | 40 | 63 | 1 1/4" | \  | - | 1/10   | 588,- *   |
| 21411250 | 1 1/2*50      | 76 | 40 | 63 | 1 1/2" | \  | - | 1/10   | 609,- *   |

## Press fitinky



### 221

T-kus

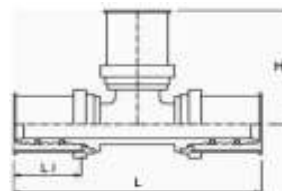

| kód      | rozměr   | L   | L1 | H  |   |   |   | balení | cena v Kč |
|----------|----------|-----|----|----|---|---|---|--------|-----------|
| 22100016 | 16*16*16 | 90  | 25 | 45 | - | - | - | 10/50  | 109,-     |
| 22100018 | 18*18*18 | 90  | 25 | 45 | - | - | - | 10/40  | 151,- *   |
| 22100020 | 20*20*20 | 90  | 25 | 45 | - | - | - | 10/40  | 138,-     |
| 22100026 | 26*26*26 | 96  | 25 | 48 | - | - | - | 5/20   | 213,-     |
| 22100032 | 32*32*32 | 104 | 25 | 52 | - | - | - | 1/10   | 321,-     |
| 22100040 | 40*40*40 | 112 | 25 | 56 | - | - | - | 1/10   | 576,- *   |
| 22100050 | 50*50*50 | 152 | 40 | 76 | - | - | - | 1/5    | 936,- *   |
| 22100063 | 63*63*63 | 166 | 37 | 83 | - | - | - | 1/5    | 2671,- *  |



### 222

T-kus redukováný střední vývod

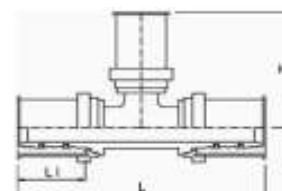

| kód      | rozměr   | L   | L1    | H  |   |   |   | balení | cena v Kč |
|----------|----------|-----|-------|----|---|---|---|--------|-----------|
| 22201816 | 18*16*18 | 90  | 25    | 45 | - | - | - | 10/50  | 163,- *   |
| 22202016 | 20*16*20 | 90  | 25    | 45 | - | - | - | 10/50  | 143,-     |
| 22202018 | 20*18*20 | 90  | 25    | 45 | - | - | - | 10/50  | 163,- *   |
| 22202616 | 26*16*26 | 96  | 25    | 48 | - | - | - | 5/20   | 223,-     |
| 22202618 | 26*18*26 | 96  | 25    | 48 | - | - | - | 5/20   | 229,- *   |
| 22202620 | 26*20*26 | 96  | 25    | 48 | - | - | - | 5/20   | 223,-     |
| 22203216 | 32*16*32 | 104 | 25    | 52 | - | - | - | 1/20   | 314,-     |
| 22203218 | 32*18*32 | 104 | 25    | 52 | - | - | - | 1/20   | 314,- *   |
| 22203220 | 32*20*32 | 104 | 25    | 52 | - | - | - | 1/20   | 314,-     |
| 22203226 | 32*26*32 | 104 | 25    | 52 | - | - | - | 1/20   | 314,-     |
| 22204026 | 40*26*40 | 112 | 25    | 56 | - | - | - | 1/10   | 537,- *   |
| 22204032 | 40*32*40 | 112 | 25    | 56 | - | - | - | 1/10   | 537,- *   |
| 22205026 | 50*26*50 | 152 | 40*25 | 63 | - | - | - | 1/5    | 838,- *   |
| 22205032 | 50*32*50 | 152 | 40*25 | 63 | - | - | - | 1/5    | 838,- *   |
| 22205040 | 50*40*50 | 152 | 40*25 | 63 | - | - | - | 1/5    | 854,- *   |



### 223

T-kus rozšířený střední vývod

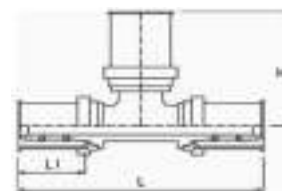

| kód      | rozměr   | L   | L1 | H  |   |   |   | balení | cena v Kč |
|----------|----------|-----|----|----|---|---|---|--------|-----------|
| 22301618 | 16*18*16 | 90  | 25 | 45 | - | - | - | 10/50  | 160,- *   |
| 22301620 | 16*20*16 | 90  | 25 | 45 | - | - | - | 10/50  | 150,-     |
| 22302026 | 20*26*20 | 96  | 25 | 48 | - | - | - | 5/20   | 220,-     |
| 22302632 | 26*32*26 | 104 | 25 | 52 | - | - | - | 1/20   | 312,-     |

## Press fitinky



### 224

T-kus redukovaný



| kód       | rozměr   | L   | L1    | H  |   |   |   | balení | cena v Kč |
|-----------|----------|-----|-------|----|---|---|---|--------|-----------|
| 224181616 | 18*16*16 | 90  | 25    | 45 | - | - | - | 10/50  | 158,- *   |
| 224201616 | 20*16*16 | 90  | 25    | 45 | - | - | - | 10/50  | 141,-     |
| 224201818 | 20*18*18 | 90  | 25    | 45 | - | - | - | 10/50  | 158,- *   |
| 224201618 | 20*16*18 | 90  | 25    | 45 | - | - | - | 10/50  | 158,- *   |
| 224202016 | 20*20*16 | 90  | 25    | 45 | - | - | - | 10/50  | 152,-     |
| 224261620 | 26*16*20 | 96  | 25    | 48 | - | - | - | 5/20   | 212,-     |
| 224161818 | 26*18*18 | 96  | 25    | 48 | - | - | - | 5/20   | 223,- *   |
| 224262016 | 26*20*16 | 96  | 25    | 48 | - | - | - | 5/20   | 223,-     |
| 224262020 | 26*20*20 | 96  | 25    | 48 | - | - | - | 5/20   | 223,-     |
| 224262616 | 26*26*16 | 96  | 25    | 48 | - | - | - | 5/20   | 223,-     |
| 224262620 | 26*26*20 | 96  | 25    | 48 | - | - | - | 5/20   | 223,-     |
| 224322026 | 32*20*26 | 104 | 25    | 52 | - | - | - | 1/20   | 314,-     |
| 224322626 | 32*26*26 | 104 | 25    | 52 | - | - | - | 1/20   | 314,-     |
| 224323220 | 32*32*20 | 104 | 25    | 52 | - | - | - | 1/20   | 314,-     |
| 224323226 | 32*32*26 | 104 | 25    | 52 | - | - | - | 1/20   | 314,-     |
| 224403232 | 40*32*32 | 112 | 25    | 56 | - | - | - | 1/20   | 537,-     |
| 224402632 | 40*26*32 | 112 | 25    | 56 | - | - | - | 1/10   | 537,- *   |
| 224404026 | 40*40*26 | 112 | 25    | 56 | - | - | - | 1/10   | 537,- *   |
| 224404032 | 40*40*32 | 112 | 25    | 56 | - | - | - | 1/10   | 537,- *   |
| 224504040 | 50*40*40 | 139 | 40*25 | 63 | - | - | - | 1/10   | 949,- *   |
| 224503240 | 50*32*40 | 139 | 40*25 | 63 | - | - | - | 1/10   | 949,- *   |
| 224505032 | 50*50*32 | 139 | 40*25 | 76 | - | - | - | 1/5    | 949,- *   |
| 224505040 | 50*50*40 | 139 | 40*25 | 76 | - | - | - | 1/5    | 949,- *   |



### 225

T-kus vnější závit

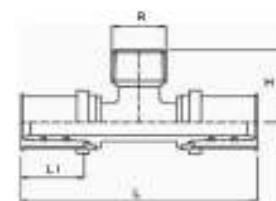

| kód      | rozměr       | L   | L1 | H  | R      |   |   | balení | cena v Kč |
|----------|--------------|-----|----|----|--------|---|---|--------|-----------|
| 22501216 | 16*1/2**16   | 92  | 25 | 29 | 1/2"   | - | - | 10/50  | 143,-     |
| 22501218 | 18*1/2**18   | 92  | 25 | 32 | 1/2"   | - | - | 10/50  | 152,- *   |
| 22501220 | 20*1/2**20   | 92  | 25 | 32 | 1/2"   | - | - | 10/40  | 143,-     |
| 22503420 | 20*3/4**20   | 98  | 25 | 36 | 3/4"   | - | - | 10/40  | 184,-     |
| 22501226 | 26*1/2**26   | 98  | 25 | 33 | 1/2"   | - | - | 5/20   | 197,-     |
| 22503426 | 26*3/4**26   | 98  | 25 | 36 | 3/4"   | - | - | 5/20   | 197,-     |
| 22500126 | 26*1**26     | 104 | 25 | 40 | 1"     | - | - | 5/20   | 236,-     |
| 22503432 | 32*3/4**32   | 104 | 25 | 38 | 3/4"   | - | - | 1/20   | 264,-     |
| 22500132 | 32*1**32     | 104 | 25 | 40 | 1"     | - | - | 1/15   | 271,-     |
| 22500140 | 40*1**40     | 112 | 25 | 45 | 1"     | - | - | 1/15   | 501,- *   |
| 22511450 | 50*1 1/4**50 | 152 | 40 | 61 | 1 1/4" | - | - | 1/5    | 818,- *   |
| 22511250 | 50*1 1/2**50 | 152 | 40 | 61 | 1 1/2" | - | - | 1/5    | 827,- *   |

## Press fitinky



**226**

T-kus vnitřní závit

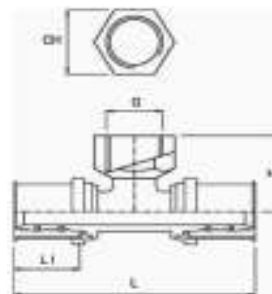

| kód      | rozměr       | L   | L1 | H  | G      | CH |   | balení | cena v Kč |
|----------|--------------|-----|----|----|--------|----|---|--------|-----------|
| 22601216 | 16*1/2**16   | 92  | 25 | 33 | 1/2"   | 25 | - | 10/50  | 133,-     |
| 22601218 | 18*1/2**18   | 92  | 25 | 35 | 1/2"   | 25 | - | 10/50  | 142,- *   |
| 22603418 | 18*3/4**18   | 98  | 25 | 42 | 3/4"   | 31 | - | 10/50  | 195,- *   |
| 22601220 | 20*1/2**20   | 92  | 25 | 35 | 1/2"   | 25 | - | 10/40  | 142,-     |
| 22603420 | 20*3/4**20   | 98  | 25 | 42 | 3/4"   | 31 | - | 10/40  | 188,-     |
| 22601226 | 26*1/2**26   | 94  | 25 | 37 | 1/2"   | 25 | - | 5/20   | 192,-     |
| 22661220 | 26*1/2**20   | 94  | 25 | 37 | 1/2"   | 25 | - | 5/20   | 245,-     |
| 22603426 | 26*3/4**26   | 98  | 25 | 42 | 3/4"   | 31 | - | 5/20   | 203,-     |
| 22601232 | 32*1/2**32   | 104 | 25 | 45 | 1/2"   | 38 | - | 1/20   | 298,-     |
| 22603432 | 32*3/4**32   | 104 | 25 | 45 | 3/4"   | 38 | - | 1/20   | 310,-     |
| 22600134 | 32*1**32     | 104 | 25 | 45 | 1"     | 38 | - | 1/15   | 287,-     |
| 22611432 | 32*1 1/4**32 | 112 | 25 | 55 | 1 1/4" | 47 | - | 1/15   | 397,-     |
| 22600140 | 40*1**40     | 112 | 25 | 55 | 1"     | 47 | - | 1/15   | 516,- *   |
| 22611440 | 40*1 1/4**40 | 112 | 25 | 55 | 1 1/4" | 47 | - | 1/10   | 516,- *   |
| 22611450 | 50*1 1/4**50 | 152 | 40 | 63 | 1 1/4" | \  | - | 1/5    | 718,- *   |
| 22611250 | 50*1 1/2**50 | 152 | 40 | 63 | 1 1/2" | \  | - | 1/5    | 849,- *   |
| 22600163 | 63*1**63     | 156 | 37 | 59 | 1"     | \  | - | 1/5    | 2363,- *  |
| 22611263 | 63*1 1/2**63 | 156 | 37 | 59 | 1 1/2" | \  | - | 1/5    | 2363,- *  |



**231**

Nástěnka

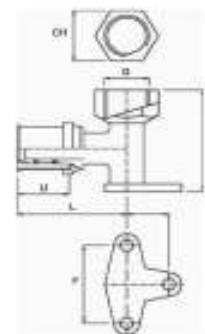

| kód      | rozměr  | L  | L1 | H  | G    | CH | F  | balení | cena v Kč |
|----------|---------|----|----|----|------|----|----|--------|-----------|
| 23193816 | 16*3/8" | 47 | 25 | 39 | 3/8" | 25 | 40 | 10/50  | 130,-     |
| 23191216 | 16*1/2" | 47 | 25 | 39 | 1/2" | 25 | 40 | 10/50  | 98,-      |
| 23101216 | 16*1/2" | 52 | 25 | 52 | 1/2" | 26 | 40 | 10/40  | 122,-     |
| 23101218 | 18*1/2" | 52 | 25 | 52 | 1/2" | 26 | 40 | 10/40  | 124,- *   |
| 23101220 | 20*1/2" | 52 | 25 | 52 | 1/2" | 26 | 40 | 10/40  | 117,-     |
| 23103420 | 20*3/4" | 52 | 25 | 52 | 3/4" | 30 | 40 | 10/30  | 150,-     |
| 23103426 | 26*3/4" | 52 | 25 | 52 | 3/4" | 30 | 40 | 5/25   | 156,-     |

## Press fitinky



### 232

Nástěnka dlouhá

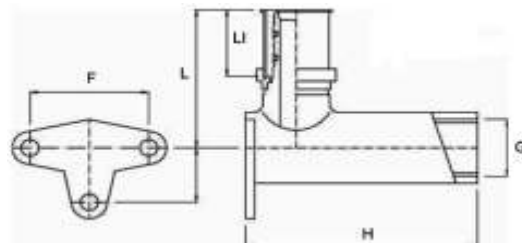

| kód      | rozměr  | L  | L1 | H         | G    | F  |   | balení | cena v Kč |
|----------|---------|----|----|-----------|------|----|---|--------|-----------|
| 23201216 | 1/2"*16 | 51 | 25 | <b>78</b> | 1/2" | 40 | - | 10/25  | 172,-     |
| 23201220 | 1/2"*20 | 51 | 25 | <b>78</b> | 1/2" | 40 | - | 10/25  | 184,-     |



### 233

Nástěnka průchozí 90°

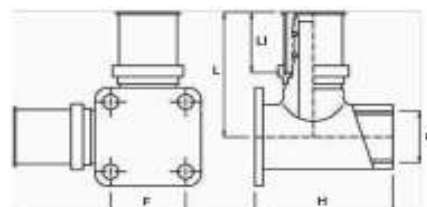

| kód      | rozměr     | L  | L1 | H  | G    | F  |   | balení | cena v Kč |
|----------|------------|----|----|----|------|----|---|--------|-----------|
| 23341216 | 16*1/2"*16 | 51 | 25 | 52 | 1/2" | 28 | - | 10/20  | 191,-     |
| 23341218 | 18*1/2"*18 | 51 | 25 | 52 | 1/2" | 28 | - | 10/20  | 207,-     |
| 23341220 | 20*1/2"*20 | 51 | 25 | 52 | 1/2" | 28 | - | 10/20  | 207,-     |



### 234

Nástěnka průchozí přímá

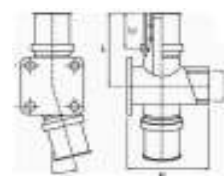

| kód      | rozměr     | L  | L1 | H         | G    |   |   | balení | cena v Kč |
|----------|------------|----|----|-----------|------|---|---|--------|-----------|
| 23481216 | 16*1/2"*16 | 51 | 25 | <b>52</b> | 1/2" | - | - | 10/20  | 207,-     |
| 23481220 | 20*1/2"*20 | 51 | 25 | <b>52</b> | 1/2" | - | - | 10/20  | 211,-     |



### 235

Nástěnka průchozí U

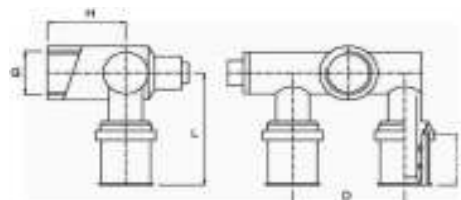

| kód      | rozměr     | L  | L1 | H         | G    | D  |   | balení | cena v Kč |
|----------|------------|----|----|-----------|------|----|---|--------|-----------|
| 23591216 | 16*1/2"*16 | 54 | 25 | <b>35</b> | 1/2" | 50 | - | 5/15   | 259,-     |
| 23591220 | 20*1/2"*20 | 54 | 25 | <b>35</b> | 1/2" | 50 | - | 5/15   | 266,-     |

## Press fitinky



### 241

Zátka

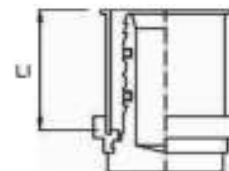

| kód      | rozměr | L  |   |   |   |   |   | balení | cena v Kč |
|----------|--------|----|---|---|---|---|---|--------|-----------|
| 24100016 | 16     | 25 | - | - | - | - | - | 10/150 | 74,-      |
| 24100018 | 18     | 25 | - | - | - | - | - | 10/150 | 74,- *    |
| 24100020 | 20     | 25 | - | - | - | - | - | 10/150 | 88,-      |
| 24100026 | 26     | 25 | - | - | - | - | - | 5/100  | 118,-     |
| 24100032 | 32     | 25 | - | - | - | - | - | 1/60   | 138,-     |
| 24100040 | 40     | 25 | - | - | - | - | - | 1/40   | 238,- *   |
| 24100050 | 50     | 40 | - | - | - | - | - | 1/30   | 396,- *   |



### 251

Koleno pro radiátory  
Cu - trubka ø15mm

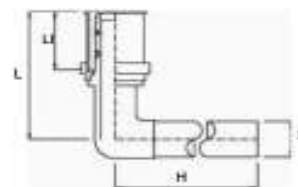

| kód      | rozměr      | L  | L1 | H    | D  |   |   | balení | cena v Kč |
|----------|-------------|----|----|------|----|---|---|--------|-----------|
| 25103016 | 16 - 300mm  | 45 | 25 | 300  | 15 | - | - | 2/30   | 195,-     |
| 25111016 | 16 - 1100mm | 45 | 25 | 1100 | 15 | - | - | 2      | 390,- *   |
| 25103018 | 18 - 300mm  | 45 | 25 | 300  | 15 | - | - | 2/30   | 252,- *   |
| 25111018 | 18 - 1100mm | 45 | 25 | 1100 | 15 | - | - | 2      | 471,- *   |
| 25103020 | 20 - 300mm  | 45 | 25 | 300  | 15 | - | - | 2/30   | 258,-     |
| 25111020 | 20 - 1100mm | 45 | 25 | 1100 | 15 | - | - | 2      | 478,- *   |



### 252

T-kus pro radiátory  
Cu - trubka ø15mm

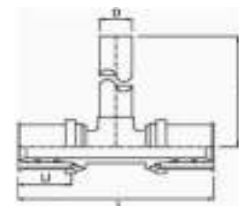

| kód      | rozměr      | L  | L1 | H    | D  |   |   | balení | cena v Kč |
|----------|-------------|----|----|------|----|---|---|--------|-----------|
| 25203016 | 16 - 300mm  | 90 | 25 | 300  | 15 | - | - | 2/20   | 247,-     |
| 25211016 | 16 - 1100mm | 90 | 25 | 1100 | 15 | - | - | 2      | 346,- *   |
| 25203018 | 18 - 300mm  | 90 | 25 | 300  | 15 | - | - | 2/20   | 331,- *   |
| 25211018 | 18 - 1100mm | 90 | 25 | 1100 | 15 | - | - | 2      | 535,- *   |
| 25203020 | 20 - 300mm  | 90 | 25 | 300  | 15 | - | - | 2/20   | 334,-     |
| 25211020 | 20 - 1100mm | 90 | 25 | 1100 | 15 | - | - | 2      | 537,- *   |

## Press fitinky



**261**  
T By-pass

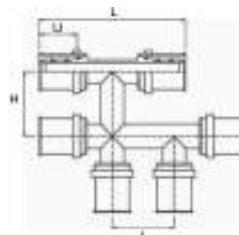

| kód      | rozměr   | L  | L1 | H  | D  |   |   | balení | cena v Kč |
|----------|----------|----|----|----|----|---|---|--------|-----------|
| 26161616 | 16*16*16 | 90 | 25 | 40 | 40 | - | - | 1/15   | 890,- *   |
| 26201616 | 20*16*16 | 90 | 25 | 40 | 40 | - | - | 1/15   | 890,- *   |
| 26201620 | 20*16*20 | 90 | 25 | 40 | 40 | - | - | 1/15   | 890,- *   |
| 26202020 | 20*20*20 | 90 | 25 | 40 | 40 | - | - | 1/15   | 890,- *   |

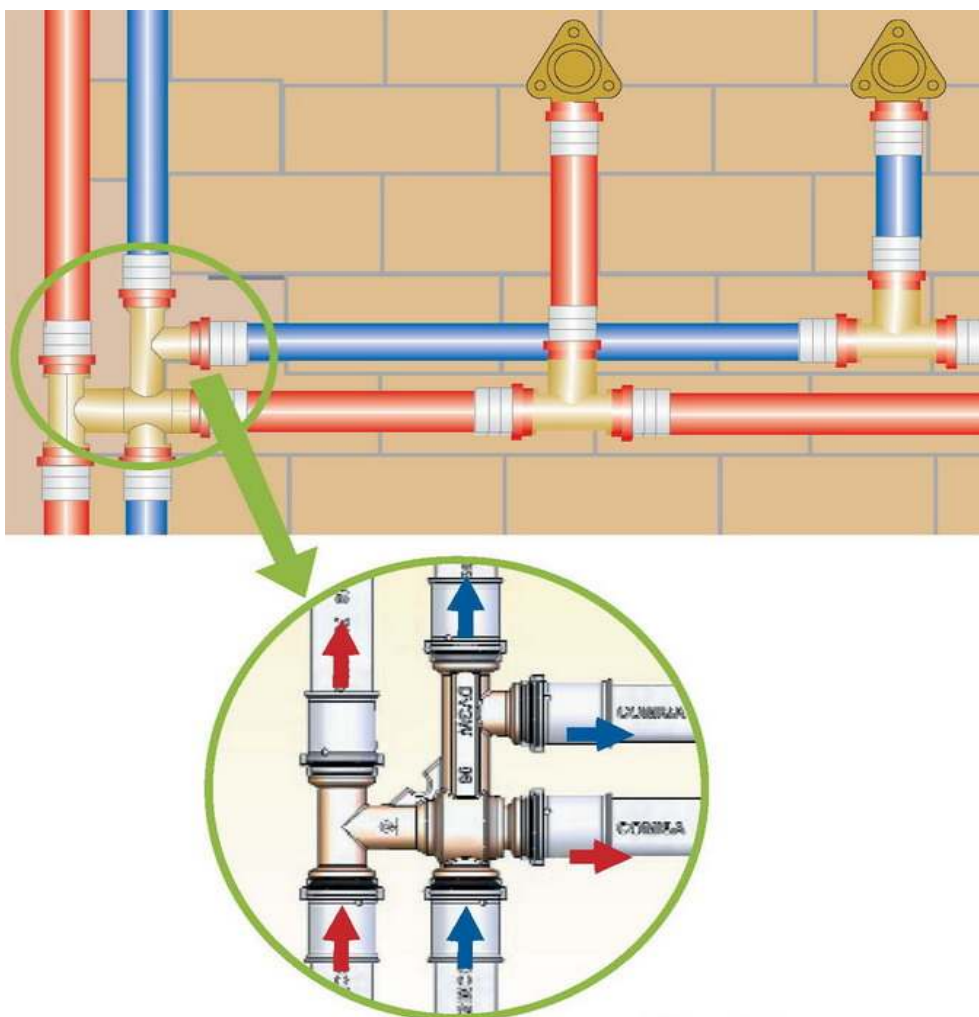

## Press fitinky



### 271

Kulový ventil  
Motýlek

| kód      | rozměr |   |   |   |   |   |   | balení | cena v Kč |
|----------|--------|---|---|---|---|---|---|--------|-----------|
| 27101616 | 16*16  | - | - | - | - | - | - | 10/30  | 298,-     |
| 27102020 | 20*20  | - | - | - | - | - | - | 10/30  | 321,-     |



### 271 Z

Kulový ventil - vnitřní závit  
Motýlek

| kód      | rozměr  |   |   |   |   |   |   | balení | cena v Kč |
|----------|---------|---|---|---|---|---|---|--------|-----------|
| 271Z1216 | 16*1/2" | - | - | - | - | - | - | 10/30  | 217,-     |
| 271Z1220 | 20*1/2" | - | - | - | - | - | - | 10/30  | 221,-     |



### 271 P

Kulový ventil  
Páka

| kód      | rozměr |   |   |   |   |   |   | balení | cena v Kč |
|----------|--------|---|---|---|---|---|---|--------|-----------|
| 271P1616 | 16*16  | - | - | - | - | - | - | 1/10   | 229,-     |
| 271P2020 | 20*20  | - | - | - | - | - | - | 1/10   | 241,-     |



### 272

Uzavírací podomítkový ventil  
S krytkou

| kód      | rozměr |   |   |   |   |   |   | balení | cena v Kč |
|----------|--------|---|---|---|---|---|---|--------|-----------|
| 27200016 | 16     | - | - | - | - | - | - | 1/10   | 413,- *   |
| 27200018 | 18     | - | - | - | - | - | - | 1/10   | 418,- *   |
| 27200020 | 20     | - | - | - | - | - | - | 1/10   | 424,- *   |

## Press fitinky



### 273 A

Vestavný uzavírací podomítkový ventil  
S krytkou a vyměnitelným horním dílem

| kód      | rozměr |   |   |   |   |   |   | balení | cena v Kč |
|----------|--------|---|---|---|---|---|---|--------|-----------|
| 273A0050 | -      | - | - | - | - | - | - | -      | 573,- *   |



### 273 B

Vestavný uzavírací podomítkový ventil  
S olivou a vyměnitelným horním dílem

| kód      | rozměr |   |   |   |   |   |   | balení | cena v Kč |
|----------|--------|---|---|---|---|---|---|--------|-----------|
| 273B0055 | -      | - | - | - | - | - | - | -      | 733,- *   |



### 273 C

Vestavný uzavírací podomítkový ventil  
S pákou a vyměnitelným horním dílem

| kód      | rozměr |   |   |   |   |   |   | balení | cena v Kč |
|----------|--------|---|---|---|---|---|---|--------|-----------|
| 273C0060 | -      | - | - | - | - | - | - | -      | 779,- *   |



### 274

Rychlospojka press (2 kusy)  
Pro ventily artikl 273

| kód      | rozměr |   |   |   |   |   |   | balení | cena v Kč |
|----------|--------|---|---|---|---|---|---|--------|-----------|
| 27400016 | 16     | - | - | - | - | - | - | -      | 158,- *   |
| 27400020 | 20     | - | - | - | - | - | - | -      | 163,- *   |



### 275

Rychlospojka vnitřní závit (2 kusy)  
Pro ventily artikl 273

| kód      | rozměr |   |   |   |   |   |   | balení | cena v Kč |
|----------|--------|---|---|---|---|---|---|--------|-----------|
| 27500012 | 1/2"   | - | - | - | - | - | - | -      | 145,- *   |
| 27500034 | 3/4"   | - | - | - | - | - | - | -      | 191,- *   |

## Press fitinky



### 276

Rychlospojka vnější závit (2 kusy)  
Pro ventily artikl 273

| kód      | rozměr |   |   |   |   |   |   |   | balení | cena v Kč |
|----------|--------|---|---|---|---|---|---|---|--------|-----------|
| 27600012 | 1/2"   | - | - | - | - | - | - | - | -      | 145,- *   |
| 27600034 | 3/4"   | - | - | - | - | - | - | - | -      | 191,- *   |



### 277

Podomítkové prodloužení  
Pro ventily artikl 273

| kód      | rozměr |   |   |   |   |   |   |   | balení | cena v Kč |
|----------|--------|---|---|---|---|---|---|---|--------|-----------|
| 27750065 | -      | - | - | - | - | - | - | - | -      | 260,- *   |



### 278

Podomítkové prodloužení  
Pro ventily artikl 272

| kód      | rozměr |   |   |   |   |   |   |   | balení | cena v Kč |
|----------|--------|---|---|---|---|---|---|---|--------|-----------|
| 27850046 | -      | - | - | - | - | - | - | - | -      | 260,- *   |



### 281

Nerezová objímka

| kód      | rozměr |   |   |   |   |   |   |   | balení | cena v Kč |
|----------|--------|---|---|---|---|---|---|---|--------|-----------|
| 28100016 | 16     | - | - | - | - | - | - | - | -      | 14,-      |
| 28100018 | 18     | - | - | - | - | - | - | - | -      | 17,- *    |
| 28100020 | 20     | - | - | - | - | - | - | - | -      | 17,-      |
| 28100026 | 26     | - | - | - | - | - | - | - | -      | 25,-      |
| 28100032 | 32     | - | - | - | - | - | - | - | -      | 29,-      |
| 28100040 | 40     | - | - | - | - | - | - | - | -      | 59,- *    |
| 28100050 | 50     | - | - | - | - | - | - | - | -      | 72,- *    |

## Press fitinky



**282**

Zátka pro nástěnky

| kód      | rozměr | barva   |   |   |   |   |   |   | balení | cena v Kč |
|----------|--------|---------|---|---|---|---|---|---|--------|-----------|
| 28280490 | 1/2"   | červená | - | - | - | - | - | - | 50     | ,-        |
| 28280491 | 1/2"   | modrá   | - | - | - | - | - | - | 50     | ,-        |



**291**

Montážní deska  
 Se 4 šrouby

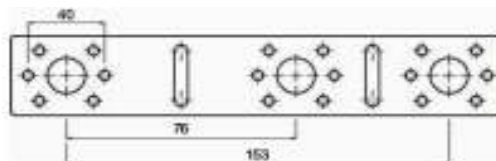

| kód      | rozměr   |   |   |   |   |   |   |   | balení | cena v Kč |
|----------|----------|---|---|---|---|---|---|---|--------|-----------|
| 29115376 | 153/76mm | - | - | - | - | - | - | - | 10/50  | 55,-      |



**291**

Montážní deska  
 Se 4 šrouby

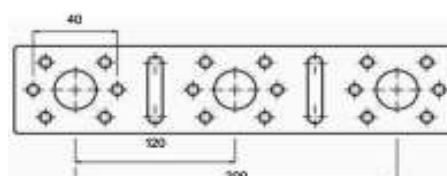

| kód      | rozměr    |   |   |   |   |   |   |   | balení | cena v Kč |
|----------|-----------|---|---|---|---|---|---|---|--------|-----------|
| 29112020 | 120/200mm | - | - | - | - | - | - | - | 10/50  | 83,-*     |



**292**

Montážní plastová deska  
 Se 6 šrouby

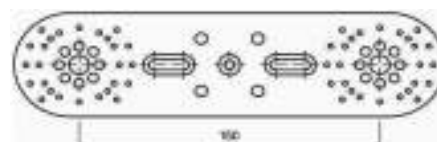

| kód      | rozměr   |   |   |   |   |   |   |   | balení | cena v Kč |
|----------|----------|---|---|---|---|---|---|---|--------|-----------|
| 29215376 | 153/76mm | - | - | - | - | - | - | - | 10/50  | 42,-*     |



**293**

Montážní šablona  
 Se 6 šrouby

| kód      | rozměr   |   |   |   |   |   |   |   | balení | cena v Kč |
|----------|----------|---|---|---|---|---|---|---|--------|-----------|
| 29315376 | 153/76mm | - | - | - | - | - | - | - | 10/50  | 184,-     |

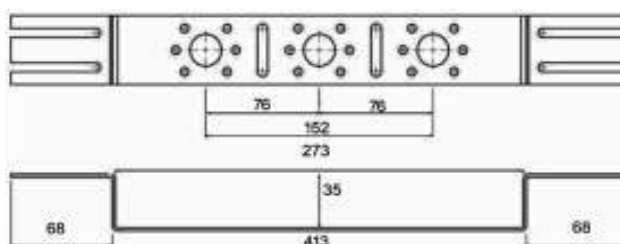
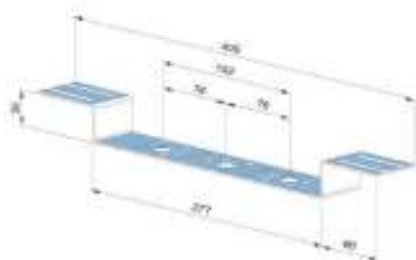

## Press fitinky



**294**  
 Nástěnný komplet  
 153 mm

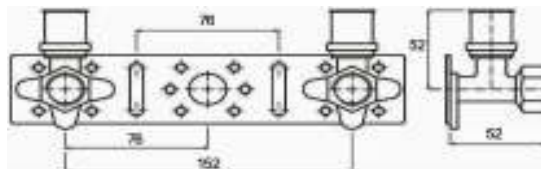

| kód      | rozměr  | rozteč | hloubka |   |   | balení | cena v Kč |
|----------|---------|--------|---------|---|---|--------|-----------|
| 29401216 | 16*1/2" | 153 mm | 52 mm   | - | - | 1/20   | 303,- *   |
| 29401220 | 20*1/2" | 153 mm | 52 mm   | - | - | 1/20   | 314,- *   |
| 29403420 | 20*3/4" | 153 mm | 52 mm   | - | - | 1/20   | 364,- *   |



**295**  
 Nástěnný komplet  
 s izolací

| kód      | rozměr  | rozteč | hloubka |   |   | balení | cena v Kč |
|----------|---------|--------|---------|---|---|--------|-----------|
| 29501216 | 16*1/2" | 153 mm | 52 mm   | - | - | 1/20   | 303,- *   |

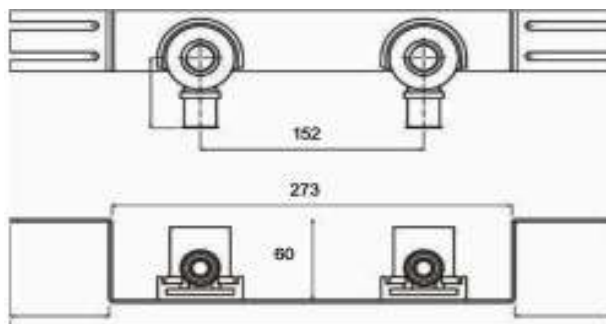
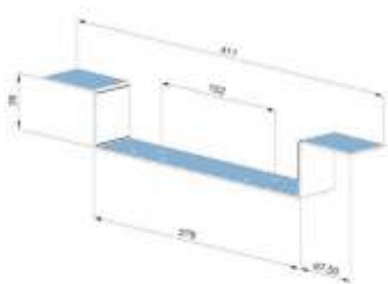

**296**  
 Izolace pro nástěnku 1/2"

-52/78

-670

| kód      | provedení  | rozměr |   |   |   |   | balení | cena v Kč |
|----------|------------|--------|---|---|---|---|--------|-----------|
| 29600052 | krátké     | 52 mm  | - | - | - | - | 10/50  | 91,-      |
| 29600078 | dlouhé     | 78 mm  | - | - | - | - | 10/40  | 133,-     |
| 29600670 | iz. krytka | -      | - | - | - | - | 10/40  | 25,-      |



**297**  
 Šablona

| kód      | provedení | rozměr |   |   |   |   | balení | cena v Kč |
|----------|-----------|--------|---|---|---|---|--------|-----------|
| 29701056 | rovné     | 56 mm  | - | - | - | - | 1/20   | 96,-      |
| 29702056 | ohýbané   | 56 mm  | - | - | - | - | 1/20   | 155,-     |

## Nářadí a nástroje



### 300

Kalibrátor s rukojetí

| kód      | rozměr |   |   |   |   |   |   | balení | cena v Kč |
|----------|--------|---|---|---|---|---|---|--------|-----------|
| 30010016 | 16     | - | - | - | - | - | - | 1      | 1081,- *  |
| 30010018 | 18     | - | - | - | - | - | - | 1      | 1081,- *  |
| 30010020 | 20     | - | - | - | - | - | - | 1      | 1081,- *  |
| 30010026 | 26     | - | - | - | - | - | - | 1      | 1111,- *  |
| 20010032 | 32     | - | - | - | - | - | - | 1      | 1347,- *  |
| 30010040 | 40     | - | - | - | - | - | - | 1      | 1452,- *  |
| 30010050 | 50     | - | - | - | - | - | - | 1      | 1611,- *  |
| 30010063 | 63     | - | - | - | - | - | - | 1      | 2441,- *  |



### 301

Kalibrovací set

| kód      | rozměr         |   |   |   |   |   |   | balení | cena v Kč |
|----------|----------------|---|---|---|---|---|---|--------|-----------|
| 30140051 | 14-16-18-20-26 | - | - | - | - | - | - | 1      | 1884,-    |



### 301

Kalibrovací set

| kód      | rozměr      |   |   |   |   |   |   | balení | cena v Kč |
|----------|-------------|---|---|---|---|---|---|--------|-----------|
| 30140052 | 16-20-26-32 | - | - | - | - | - | - | 1      | 1635,-    |



### 301

Kalibrovací set

| kód      | rozměr      |   |   |   |   |   |   | balení | cena v Kč |
|----------|-------------|---|---|---|---|---|---|--------|-----------|
| 30140053 | 16-18-20-26 | - | - | - | - | - | - | 1      | 855,-     |



### 302 R

Rukojeť kalibrátoru

| kód      | rozměr         |   |   |   |   |   |   | balení | cena v Kč |
|----------|----------------|---|---|---|---|---|---|--------|-----------|
| 30272480 | 14-16-18-20-26 | - | - | - | - | - | - | 1      | 1099,- *  |

## Nářadí a nástroje



**302**  
Kalibrátor

| kód      | rozměr |   |   |   |   |   | balení | cena v Kč |
|----------|--------|---|---|---|---|---|--------|-----------|
| 30272416 | 16     | - | - | - | - | - | 1      | 855,- *   |
| 30272418 | 18     | - | - | - | - | - | 1      | 855,- *   |
| 30272420 | 20     | - | - | - | - | - | 1      | 855,- *   |
| 30272426 | 26     | - | - | - | - | - | 1      | 879,- *   |
| 30272432 | 32     | - | - | - | - | - | 1      | 1147,- *  |
| 30272440 | 40     | - | - | - | - | - | 1      | 1257,- *  |
| 30272450 | 50     | - | - | - | - | - | 1      | 1416,- *  |
| 30272463 | 63     | - | - | - | - | - | 1      | 2319,- *  |



**305**  
Měřidlo ke kontrole zalisování TH 16-20-26

| kód      | rozměr      |   |   |   |   |   | balení | cena v Kč |
|----------|-------------|---|---|---|---|---|--------|-----------|
| 30530024 | TH 16-20-26 | - | - | - | - | - | 1      | 3661,- *  |



**310**  
Řezák trubek

| kód      | rozměr |   |   |   |   |   | balení | cena v Kč |
|----------|--------|---|---|---|---|---|--------|-----------|
| 31001463 | 14-63  | - | - | - | - | - | 1      | 4442,- *  |



**310**  
Řezák trubek

| kód      | rozměr |   |   |   |   |   | balení | cena v Kč |
|----------|--------|---|---|---|---|---|--------|-----------|
| 31001432 | 14-32  | - | - | - | - | - | 1      | 1733,- *  |



**311**  
Náhradní nůž pro řezák trubek 14/32

| kód      | rozměr |   |   |   |   |   | balení | cena v Kč |
|----------|--------|---|---|---|---|---|--------|-----------|
| 31121432 | 14-32  | - | - | - | - | - | 1      | 855,- *   |

## Nářadí a nástroje



### 320

Pružiny pro ohýbání trubek

| vnitřní kód | rozměr |   |   |   |   |   |   | balení | cena v Kč |
|-------------|--------|---|---|---|---|---|---|--------|-----------|
| 32025016    | 16     | - | - | - | - | - | - | 1      | 310,- *   |
| 32025018    | 18     | - | - | - | - | - | - | 1      | 342,- *   |
| 32025020    | 20     | - | - | - | - | - | - | 1      | 379,- *   |
| 32025026    | 26     | - | - | - | - | - | - | 1      | 440,- *   |

| vnější kód | rozměr |   |   |   |   |   |   | balení | cena v Kč |
|------------|--------|---|---|---|---|---|---|--------|-----------|
| 32042016   | 16     | - | - | - | - | - | - | 1      | 367,- *   |
| 32042018   | 18     | - | - | - | - | - | - | 1      | 489,- *   |
| 32042020   | 20     | - | - | - | - | - | - | 1      | 489,- *   |
| 32042026   | 26     | - | - | - | - | - | - | 1      | 684,- *   |



### 330

Odvíječ trubek

| kód      | rozměr |   |   |   |   |   |   | balení | cena v Kč |
|----------|--------|---|---|---|---|---|---|--------|-----------|
| 33020031 | -      | - | - | - | - | - | - | 1      | 10249,- * |



### 331

Rovnačka trubek

| kód      | rozměr |   |   |   |   |   |   | balení | cena v Kč |
|----------|--------|---|---|---|---|---|---|--------|-----------|
| 33130046 | -      | - | - | - | - | - | - | 1      | 10249,- * |



### 332

Ruční ohýbačka

| kód      | rozměr |   |   |   |   |   |   | balení | cena v Kč |
|----------|--------|---|---|---|---|---|---|--------|-----------|
| 33241016 | 16     | - | - | - | - | - | - | 1      | 3173,- *  |
| 33242020 | 20     | - | - | - | - | - | - | 1      | 3417,- *  |

## Nářadí a nástroje



### 340

Runí lisovací kleště

| kód      | rozměr |   |   |   |   |   | balení | cena v Kč |
|----------|--------|---|---|---|---|---|--------|-----------|
| 34080418 | -      | - | - | - | - | - | 1      | 6174,- *  |



### 341

Čelisti pro ruční lisovací kleště  
Jen pro artikl 340

| kód      | rozměr |   |   |   |   |   | balení | cena v Kč |
|----------|--------|---|---|---|---|---|--------|-----------|
| 34180560 | 16     | - | - | - | - | - | 1      | 4320,- *  |
| 34180561 | 20     | - | - | - | - | - | 1      | 4320,- *  |
| 34180562 | 26     | - | - | - | - | - | 1      | 4320,- *  |



### 342

Runí lisovací kleště s kufrem a vložkami TH 16-20-26

| kód      | rozměr |   |   |   |   |   | balení | cena v Kč |
|----------|--------|---|---|---|---|---|--------|-----------|
| 34280520 | -      | - | - | - | - | - | 1      | 17618,- * |



### 342

Runí lisovací kleště s kufrem bez vložek

| kód      | rozměr |   |   |   |   |   | balení | cena v Kč |
|----------|--------|---|---|---|---|---|--------|-----------|
| 34280419 | -      | - | - | - | - | - | 1      | 12933,- * |



### 343

Vložky do ručních lisovacích kleští TH

| kód      | rozměr |   |   |   |   |   | balení | cena v Kč |
|----------|--------|---|---|---|---|---|--------|-----------|
| 34380522 | 16     | - | - | - | - | - | 1      | 1709,- *  |
| 34380523 | 18     | - | - | - | - | - | 1      | 1709,- *  |
| 34380524 | 20     | - | - | - | - | - | 1      | 1709,- *  |
| 34380525 | 26     | - | - | - | - | - | 1      | 1709,- *  |

## Nářadí a nástroje



### 345

Mini Aku přístroj na lisování bez čelistí - 1 Aku a 1 nabíječka

| kód      | provedení |   |   |   |   |   | balení | cena v Kč |
|----------|-----------|---|---|---|---|---|--------|-----------|
| 34580421 | lis       | - | - | - | - | - | 1      | 41971,- * |



### 345

Náhradní díly

|          |           |   |   |   |   |   |   |          |
|----------|-----------|---|---|---|---|---|---|----------|
| 34580476 | Aku 2.0Ah | - | - | - | - | - | 1 | 4198,- * |
| 34580485 | Aku 3.0Ah | - | - | - | - | - | 1 | 5125,- * |
| 34580477 | Nabíječka | - | - | - | - | - | 1 | 4930,- * |



### 346

Čelisti do Mini Aku lisu artikl 345

| kód      | rozměr |   |   |   |   |   | balení | cena v Kč |
|----------|--------|---|---|---|---|---|--------|-----------|
| 34680422 | 16     | - | - | - | - | - | 1      | 4124,- *  |
| 34680481 | 18     | - | - | - | - | - | 1      | 4124,- *  |
| 34680426 | 20     | - | - | - | - | - | 1      | 4124,- *  |
| 34680424 | 26     | - | - | - | - | - | 1      | 4271,- *  |
| 34680482 | 32     | - | - | - | - | - | 1      | 4515,- *  |



### 347

Elektronický Aku lis JB-APS32

| kód      | provedení |   |   |   |   |   | balení | cena v Kč |
|----------|-----------|---|---|---|---|---|--------|-----------|
| 34780515 | lis       | - | - | - | - | - | 1      | 70277,- * |

#### Náhradní díly

|          |             |   |   |   |   |   |   |          |
|----------|-------------|---|---|---|---|---|---|----------|
| 34780516 | Aku baterie | - | - | - | - | - | 1 | 7199,- * |
| 34780517 | Nabíječka   | - | - | - | - | - | 1 | 6223,- * |

S kufrem, bez čelistí  
Li-Ion Aku 14,4V/2,6Ah  
Nabíječka  
Software pro analýzu  
Propojovací USB-kabel

USB-propojení pro běžné počítače k úplné diagnóze (celkový pracovní čas, počet slisování, čas do servisu, stav aku baterie, atd.)  
Optické hlášení o poruchách a pohotovostní hlášení  
Kompatibilní se všemi obvyklými lisovacími čelistmi a lisovacími řetězi  
Otočná lisovací hlava - 360°  
Automatický vratný chod pístu po slisování

## Nářadí a nástroje



### 348

Elektronický elektrický lis JB-APS32

| kód           | provedení             |   |   |   |   |   | balení | cena v Kč |
|---------------|-----------------------|---|---|---|---|---|--------|-----------|
| 34880518      | lis                   | - | - | - | - | - | 1      | 58564,- * |
| Náhradní díly |                       |   |   |   |   |   |        |           |
| 34880519      | Adaptér 220V+5m kabel | - | - | - | - | - | 1      | 14641,- * |

S kufrem, bez čelistí  
Adaptér 220V s 5m kabelem  
Software pro analýzu  
Propojovací USB-kabel

USB-propojení pro běžné počítače k úplné diagnóze (celkový pracovní čas, počet slisování, čas do servisu, stav aku baterie, atd.)  
Optické hlášení o poruchách a pohotovostní hlášení  
Kompatibilní se všemi obvyklými lisovacími čelistmi a lisovacími řetězi  
Otočná lisovací hlava - 360°  
Automatický vratný chod pístu po slisování



### 351

Lisovací čelisti  
TH-profil

| kód      | rozměr |   |   |   |   |   | balení | cena v Kč |
|----------|--------|---|---|---|---|---|--------|-----------|
| 35180407 | 16     | - | - | - | - | - | 1      | 3710,- *  |
| 35180409 | 18     | - | - | - | - | - | 1      | 3710,- *  |
| 35180410 | 20     | - | - | - | - | - | 1      | 3710,- *  |
| 35180412 | 26     | - | - | - | - | - | 1      | 4027,- *  |
| 35180413 | 32     | - | - | - | - | - | 1      | 4930,- *  |
| 35180414 | 40     | - | - | - | - | - | 1      | 6101,- *  |
| 35180415 | 50     | - | - | - | - | - | 1      | 13421,- * |



| kód      | rozměr |   |   |   |   |   | balení | cena v Kč |
|----------|--------|---|---|---|---|---|--------|-----------|
| 35180457 | 63     | - | - | - | - | - | 1      | 28794,- * |



### 355

Univerzální lisovací čelisti 14-32 - bez vložek

| kód      | rozměr |   |   |   |   |   | balení | cena v Kč |
|----------|--------|---|---|---|---|---|--------|-----------|
| 35580540 | 14-32  | - | - | - | - | - | 1      | 5369,- *  |

## Nářadí a nástroje



### 356

Vložky do univerzálních lisovacích čelistí  
 TH-profil

| kód      | rozměr |   |   |   |   |   |   | balení | cena v Kč |
|----------|--------|---|---|---|---|---|---|--------|-----------|
| 35680542 | 16     | - | - | - | - | - | - | 1      | 2075,- *  |
| 35680543 | 18     | - | - | - | - | - | - | 1      | 2319,- *  |
| 35680544 | 20     | - | - | - | - | - | - | 1      | 2319,- *  |
| 35680545 | 26     | - | - | - | - | - | - | 1      | 2563,- *  |
| 35680546 | 32     | - | - | - | - | - | - | 1      | 2685,- *  |



### 358

Kufřík na nářadí

| kód      | rozměr |   |   |   |   |   |   | balení | cena v Kč |
|----------|--------|---|---|---|---|---|---|--------|-----------|
| 35880650 | -      | - | - | - | - | - | - | 1      | 855,- *   |



### 359 A

SET "A"

| kód      | rozměr |   |   |   |   |   |   | balení | cena v Kč |
|----------|--------|---|---|---|---|---|---|--------|-----------|
| 35980530 | -      | - | - | - | - | - | - | 1      | 14397,- * |

Obsahuje: Kufřík  
 Univerzální lisovací čelisti 14-32  
 Vložky do čelistí TH 16-20-26  
 Kalibrátor 16-20-26  
 Rukojeť kalibrátoru



### 359 B

SET "B"

| kód      | rozměr |   |   |   |   |   |   | balení | cena v Kč |
|----------|--------|---|---|---|---|---|---|--------|-----------|
| 35980535 | -      | - | - | - | - | - | - | 1      | 9737,- *  |

Obsahuje: Kufřík  
 Kalibrátor 14-16-18-20-26-32-40-50  
 Rukojeť kalibrátoru